



CONTEMPORANEO

CONTEMPORARY

MANIGLIE PONTE

BRIDGE HANDLES

MODEL
12968

MAT.: ZINKRAL

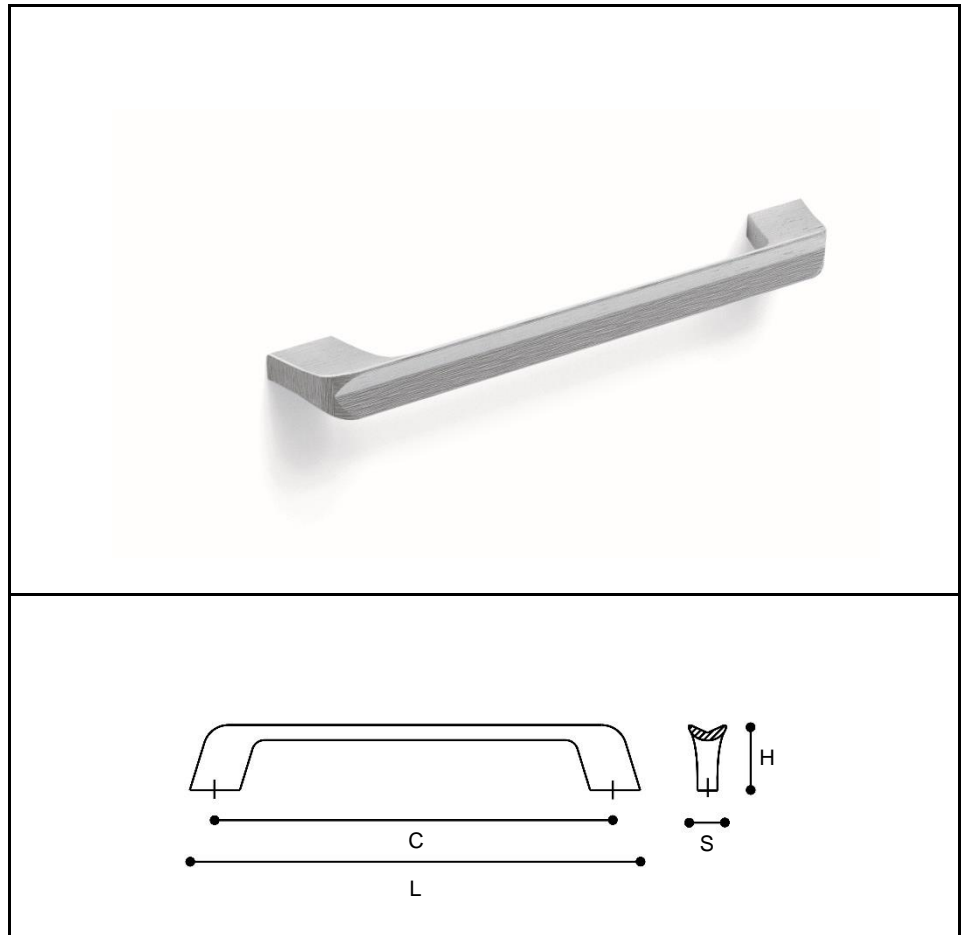

Code	Width (L)	Holes Gap (C)	Height (H)	Depth (S)	Weight (gr.)
12968.B	116	96	26	15	80
12968.G	180	160	26	15	100
12968.N	340	320	26	15	168